

FCG12-120

Product Image

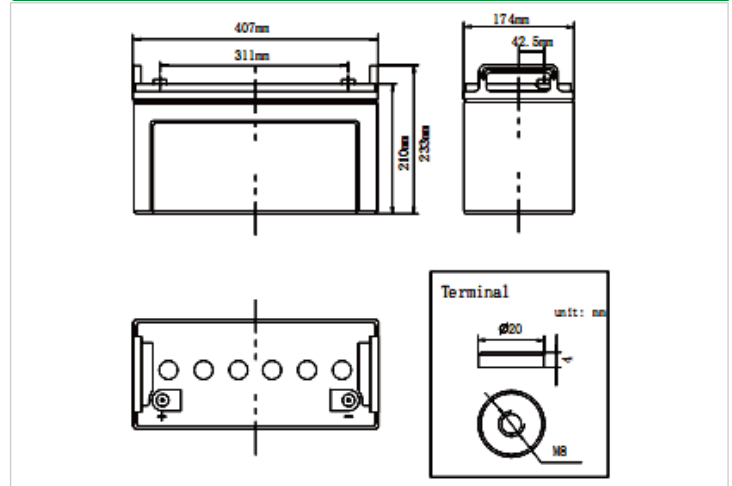

Product Dimensions



Cycle Service Life(25°C/77°F)

Characteristics

Nominal Voltage		12V
Nominal Capacity (10 hour rate)		120Ah
Capacity 25°C(77°F)	20 hour rate (6.66A)	133.2Ah
	5 hour rate (21.9A)	109.5Ah
	1 hour rate (79.8A)	79.8Ah
Internal Resistance	Full Charged Battery 25°C	≤5.0m Ω
Capacity affected by Temperature (10 hour)	40°C (104°F)	102%
	25°C (77°F)	100%
	0°C (32°F)	90%
	-15°C (5°F)	70%
Self-Discharge 25°C(77°F) Capacity	after 3 month storage	92%
	after 6 month storage	84%
	after 12 month storage	65%
Charge (Constant Voltage) 25°C (77°F)	Float	Initial Charging Current Less than24.0A Voltage 13.6-13.8V
	Cycle	Initial Charging Current Less than24.0A Voltage 14.4-14.9V

Packaging

Battery Dimensions	Length	407mm
	Width	174mm
	Height	210mm
	Total Height	233mm
Box Dimensions	Length	422mm
	Width	188mm
	Height	290mm
Quantity Per Box		1 PC per box
Net weight Per Cell		34.0kg±400g
Net weight Per Box		34.0kg
Gross Weight		34.5kg

Discharge Constant Current (Amperes at 77°F25°C)

F.V/Time	5min	10min	15min	30min	45min	1h	2h	3h	5h	8h	10h	20h
1.60V	403.5	268.8	202.6	126.1	90.5	79.8	48.7	35.6	22.9	14.0	12.48	6.93
1.65V	372.0	247.8	194.2	122.7	88.0	77.7	47.8	34.9	22.6	13.8	12.36	6.86
1.70V	378.3	252.0	185.7	119.3	85.6	75.6	46.9	34.3	22.2	13.7	12.24	6.79
1.75V	334.2	222.6	177.3	115.9	83.2	73.4	45.8	33.5	21.9	13.6	12.12	6.73
1.80V	315.2	210.0	168.8	112.6	80.8	71.3	44.6	32.6	21.6	13.4	12.00	6.66

Discharge Constant Power (Watts at 77°F 25°C)

F.V/Time	5min	10min	15min	30min	45min	1h	2h	3h	5h	8h	10h	20h
1.60V	752.5	501.3	377.9	235.1	168.7	148.9	90.7	66.4	42.7	26.1	23.3	12.9
1.65V	693.7	462.1	362.1	228.8	164.2	144.9	89.1	65.1	42.1	25.8	23.1	12.8
1.70V	705.5	470.0	346.4	222.5	159.7	140.9	87.4	63.9	41.5	25.6	22.8	12.7
1.75V	623.2	415.1	330.6	216.2	155.1	136.9	85.3	62.4	40.9	25.3	22.6	12.5
1.80V	587.9	391.7	314.9	209.9	150.6	132.9	83.3	60.9	40.3	25.1	22.4	12.4

Charging characteristics

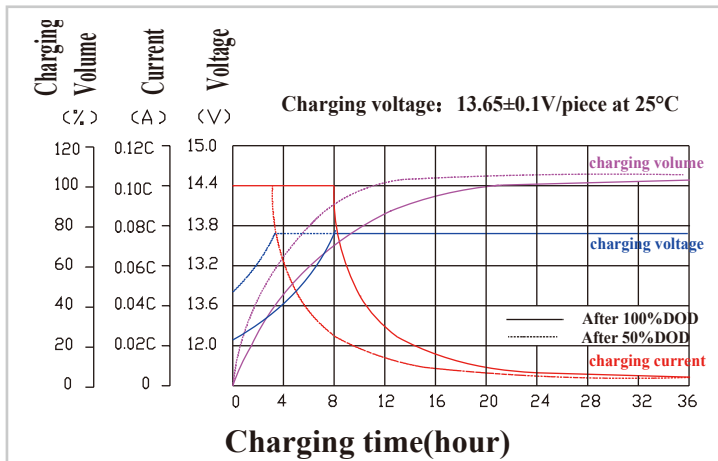

Temperature effect on float charging life

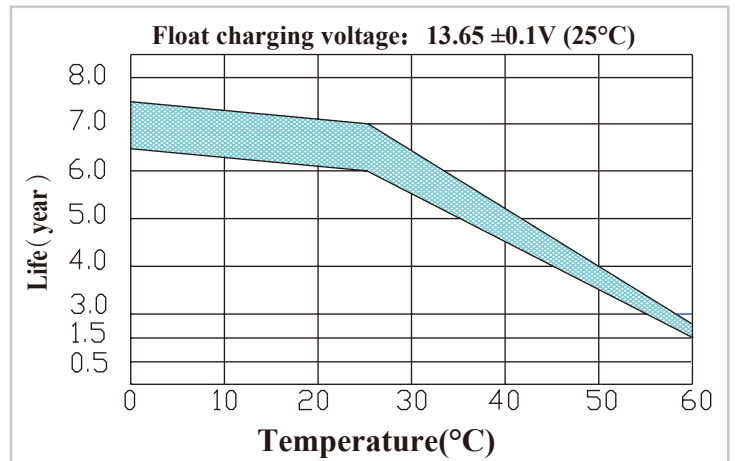

Cycle life vs. Depth of discharge (25°C)

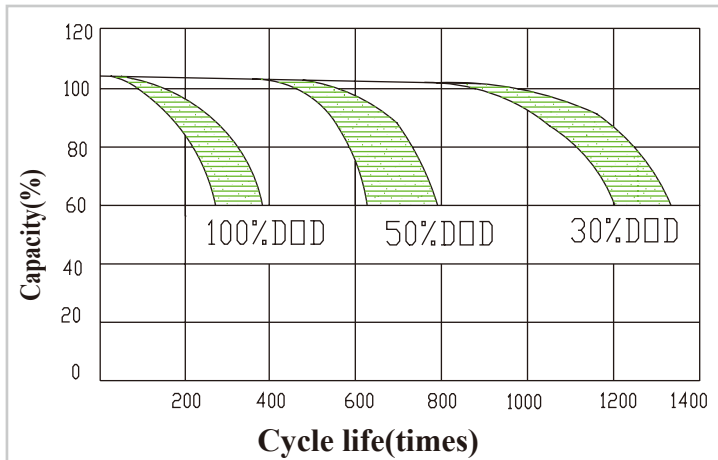

Discharge characteristics (25°C)

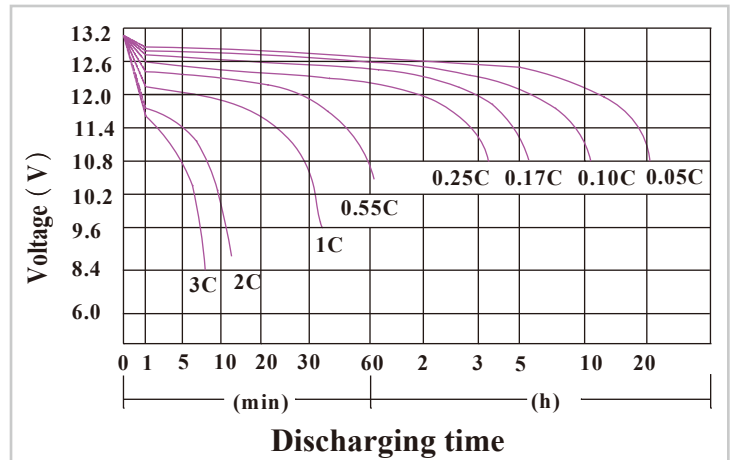

Temperature effect on battery self-discharge

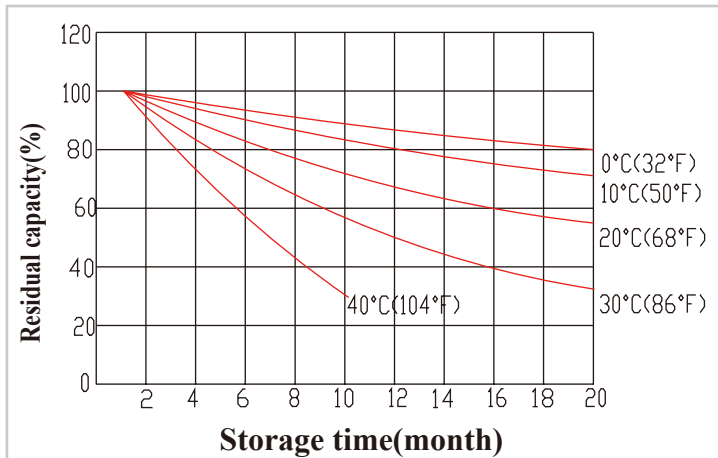

Temperature effect on capacity

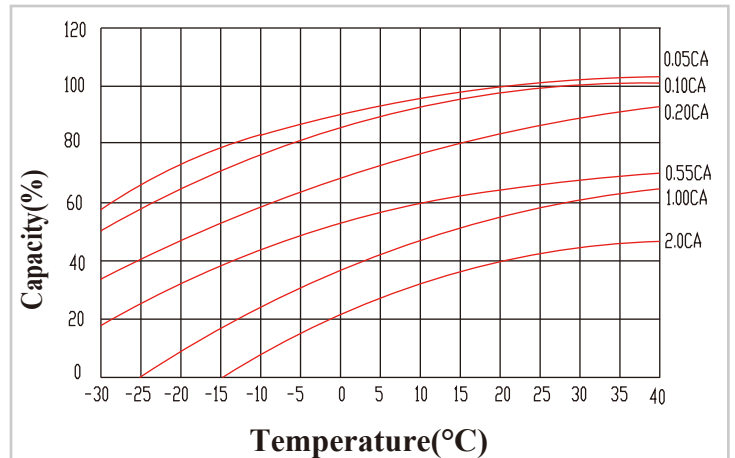

Battery Construction

Component	Positive plate	Negative plate	Container	Cover	Safety valve	Terminal	Separator	Electrolyte
Raw material	Lead dioxide	Lead	ABS	ABS	Si-Rubber	Copper	Fiberglass	GEL